

Premium Preparation 1200 mm Wall Cupboard with 2 Sliding Doors

ITEM # _____

MODEL # _____

NAME # _____

SIS # _____

AIA # _____



133119 (PS1200EN)

 Wall Cupboard, with 1 shelf
and 2 sliding doors, 1200mm

Short Form Specification

Item No. _____

Made entirely from 304 AISI stainless steel, 0,8mm in thickness. Inner welded frame in stainless steel. Uprturned panel edges. 10mm radiused corner between base and back panel for a perfect cleanability. 50mm top and base panel. Intermediate shelf adjustable at three different heights. Two sound-deadened sliding doors.

Main Features

- Handles in stainless steel for better hygiene and reliability.
- Sturdiness, stability and reliability of table accurately tested.

Construction

- Wall cupboard features an ergonomic handle and an internal shelf which can be positioned at three different levels.
- Easy access to the cupboard interior on all lengths guaranteed by the use of only 2 doors.
- Inner welded frame in stainless steel to guarantee superior strength and stability.
- Sturdy sound-deadened sliding doors on tracks located flush to the front of the frame.
- 100 mm upstand with 10 mm radiused corner and 13 mm deep, designed to be used against a wall.
- Scotch Brite finish to meet the highest hygiene standards.
- Heavy duty construction entirely in AISI 304 stainless steel to offer maximum durability.

Optional Accessories

- Lighting kit with led for wall cupboards (1000mm and 1200mm) PNC 850709
- Lighting kit with led for wall cupboards (1400mm, 1600mm and 1800mm) PNC 850710

APPROVAL: _____



Front

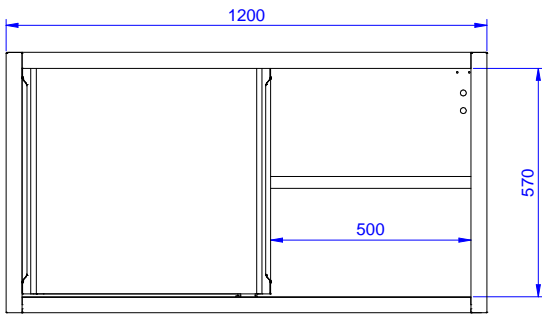

Side

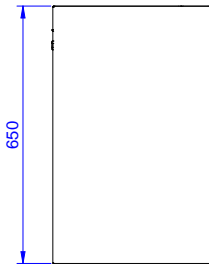

Top

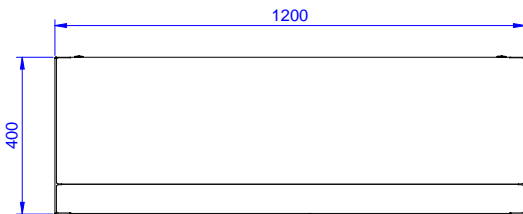

Key Information:

Cabinet width:	
133119 (PS1200EN)	1188 mm
Cabinet depth:	333 mm
Cabinet height:	570 mm
N° of doors:	2
External dimensions, Width:	1200 mm
External dimensions, Depth:	400 mm
External dimensions, Height:	650 mm
Net weight:	29 kg